

# fermacell

## flooring elements

European Technical Approval

Validity: to 01.06.2018

**fermacell**<sup>®</sup>





## I LEGAL BASES AND GENERAL CONDITIONS

- 1 This European Technical Approval is issued by Kiwa Nederland B.V., Certificatie en Keuringen, further mentioned as Kiwa Nederland B.V., in accordance with:
  - Council Directive 89/106/EEC of 21 December 1988 on the approximation of laws, regulations and administrative provisions of Member States relating to construction products<sup>1</sup>, modified by the Council Directive 93/68/EEC<sup>2</sup> and Regulation (EC) N° 1882/2003 of the European Parliament of the Council<sup>3</sup>;
  - Common Procedural Rules for Requesting, Preparing and the Granting of European technical approvals set out in the Annex of Commission Decision 94/23/EC<sup>4</sup>.
  - Guideline for European technical approval of august 1, 2009 Insulating floor finishing systems with flooring elements, CUAP no 05.02/03
- 2 Kiwa Nederland B.V. is authorized to check whether the provisions of this European technical approval are met. Checking may take place in the manufacturing plant. Nevertheless, the responsibility for the conformity of the products to the European technical approval and for their fitness for the intended use remains with the holder of the European technical approval.
- 3 This European technical approval is not to be transferred to manufacturers or agents of manufacturers other than those indicated on page 1 of this European technical approval.
- 4 This European technical approval may be withdrawn by Kiwa Nederland B.V., in particular after information by the Commission on the basis of Article 5 (1) of Council Directive 89/106/EEC.
- 5 Reproduction of this European technical approval including transmission by electronic means is in full. However, partial reproduction can be made with the written consent of Kiwa Nederland B.V.. In this case partial reproduction has to be designated as such. Texts and drawings of advertising brochures shall not contradict or misuse the European technical approval.
- 6 The European technical approval is issued by the approval body in the English language. The version corresponds to the English version which is circulated within EOTA. Translations into other languages have to be designated as such.

---

<sup>1</sup> Official Journal of the European Communities N° L 40, 11.02.1989, p. 12

<sup>2</sup> Official Journal of the European Communities N° L 220, 30.08.1993, p. 1

<sup>3</sup> Official Journal of the European Union N° L 284, 31 October 2003, p. 25

<sup>4</sup> Official Journal of the European Communities N° L17, 20 Jan 1994, p 34.

## II SPECIFIC CONDITIONS OF THE EUROPEAN TECHNICAL APPROVAL

### 1 Definition of products and intended use

The insulating dry floor finishing systems are built up with prefabricated flooring elements and other components that are specified in the technical approval. The flooring elements and the other components are forming a kit.

#### 1.1 FERMACELL flooring elements

The FERMACELL flooring elements exist of two homogeneous gypsum fibre boards that are glued with an overlap. The gypsum fibre boards are made of natural or Fluegas desulphurisation (FGD-) gypsum and paper fibres. Under these gypsum fibre boards there can be glued an insulation board made of wood fibre, mineral wool, EPS hardfoam or any other Insulation material. The thickness of the used gypsum fibre boards and insulation board can vary. An example of a flooring element is shown in the following figure.

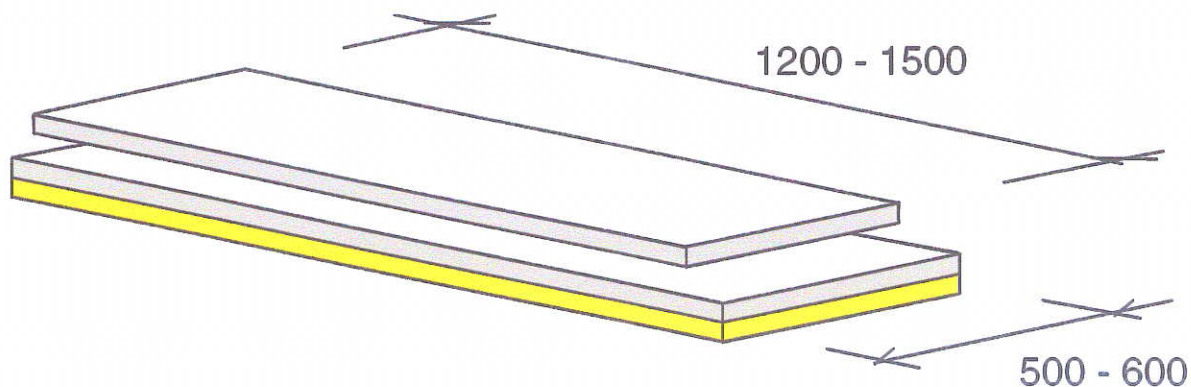

- Woodfibre as defined in EN 13171.
- EPS is expanded polystyrene as defined in EN 13163.
- Mineral wool as defined in EN 13162.

#### 1.2 Other components

- FERMACELL dry levelling compound: grinded aerated-concrete.
- FERMACELL dry acoustical compound: limestone split.
- FERMACELL honey comb board.
- FERMACELL floor glue.

Characteristics of these products are given in chapter 2.  
Their intended use is described in 1.4 (page 6).





Auxiliary materials:

- FERMACELL flooring screws.
- FERMACELL joint filler: joint filler based on gypsum.
- Flooring perimeter insulation: strips of PE-foam, mineral wool or wood fibre.
- Flooring paper: trickle proof barrier.

### 1.3 Insulating floor finishing systems

Two kinds of insulating floor finishing systems can be distinguished:

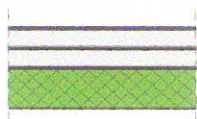
- systems with only FERMACELL flooring elements which are directly installed on the structural floor (table 1: type 1 to 6);
- systems which consist of FERMACELL flooring elements with additional layers (table 2).

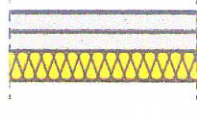
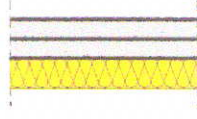
Type	Ref. No	examples of insulating floor finishing systems	depth [mm]	System drawing
1	2 E 11	2 x 10 mm gypsum fibre boards	20	
2	2 E 22	2 x 12,5 mm gypsum fibre boards	25	
3	2 E 13	2 x 10 mm gypsum fibre boards and 20 mm EPS DEO 100 kPa hard foam	40	
4	2 E 14	2 x 10 mm gypsum fibre boards and 30 mm EPS DEO 100 kPa hard foam	50	
5	2 E 31	2 x 10 mm gypsum fibre boards and 10 mm wood fibre	30	
6	2 E 32	2 x 10 mm gypsum fibre boards and 10 mm mineral wool	30	

**Table 1**  
 FERMACELL flooring elements which could be directly installed on the structural floor.

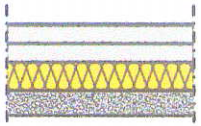
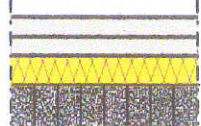
type	flooring elements	additional layer	depth [mm]	System drawing
7	under each type 1 to 7	10 to 60 mm FERMACELL levelling compound on each type (1 to 6)	30 - 140	
8	2 E 13 a 2 E 14 a	10 mm gypsum fibre boards on 2 E 13, 2 E 14	50 60	
9	2 E 22 a	10 mm gypsum fibre boards on 2 E 22	35	
10	2 E 31 a	10 mm gypsum fibre boards on 2 E 31	40	
11	2 E 32 a	10 mm gypsum fibre boards on 2 E 32	40	
12	2 E 31	FERMACELL honey comb system: 2 E 31 on FERMACELL dry acoustical compound	60 – 90	
13	2 E 32	FERMACELL honey comb system: 2 E 32 on FERMACELL dry acoustical compound:	60 - 90	

**Table 2**

System which consists of FERMACELL flooring elements with additional layers (see also remark by 5.2).

#### 1.4 Intended use

The insulating dry floor finishing systems with FERMACELL flooring elements are intended for use in new build and existing (refurbishment) houses and other buildings for raising the height of floors or leveling out uneven floors. They can only be used on structural floors which provide overall support to the flooring elements. The floor finishing systems are only exposed to static loads.

The space below the floor on which the floor finishing systems are used can be either an interior environment or exposed to the elements. The phrase exposed to the elements is a way of saying that the underside of the floor structure is subject to wind, external temperatures etc.

The floor finishing systems are not intended to be used without a floor covering. In wet rooms the floor finishing systems must be lined with a waterproof floor covering. This covering has to be according to the national standards.

FERMACELL dry leveling compound, grinded aerated concrete used for level out floors.

FERMACELL honey comb board, honey comb looking cardboard in 30 mm or 60 mm height (see below).

FERMACELL dry acoustical compound, limestone split for filling the honey comb board. Both parts together build the honey comb system (Table 2, page 5), which intended use is to increase the sound insulation of timber floor ceilings (see below).

The intended working life of the insulating floor finishing systems is assumed to be at least 25 years.

The indication given of the working life of a system cannot be interpreted as a guarantee given by the producer (or the approval body) but is regarded only as a mean of choosing the right products in relation to the expected economically reasonable working life.

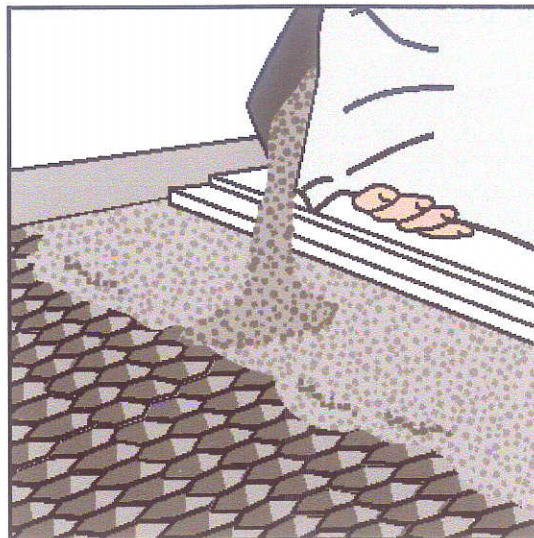

honey comb board with dry acoustical compound

## 2 CHARACTERISTICS OF PRODUCT AND METHODS OF VERIFICATION

### 2.1 Geometry

#### 2.1.1 Gypsum fibre boards

The dimensions of the gypsum fibre boards are:

- Length: 1200 to 1500 mm
- Width: 500 to 600 mm
- Thickness: 2 x 10 or 2 x 12,5 mm

With the following tolerances determined according to EN 520:

- Length:  $\pm 1$  mm
- Width:  $\pm 1$  mm
- Thickness:  $\pm 0,5$  mm
- Squareness:  $+ 2,0$  mm

#### 2.1.2 Insulation boards

The dimensions<sup>1)</sup> of the insulation board according to EN 822, prEN 12431 and EN 824 are:

EPS DEO 100 kPa hard foam: 1500 x 500 x 20 mm<sup>3</sup>, dL= 30,0 mm and dB= 29,6 mm

1500 x 500 x 30 mm<sup>3</sup>, dL= 20,0 mm and dB= 19,7 mm

mineral wool: 1500 x 500 x 10 mm<sup>3</sup>, dL= 11,2 mm and dB= 10,6 mm

wood fibre: 1500 x 500 x 10 mm<sup>3</sup>, dL= 10,3 mm and dB= 10,0 mm

1) Dimensions may vary depending on the insulationboard used.

The dimensions are in accordance with following tolerances:

Length:  $+ 0/-2$  mm

Width:  $+ 0/-2$  mm

Thickness dL:  $\pm 0,5$  mm

Thickness dB:  $\pm 0,5$  mm

Squareness:  $+ 2,0$  mm

#### 2.1.3 FERMACELL flooring elements

The dimensions of the overlap is 50 mm.

The tolerance is:  $\pm 1$  mm

#### 2.1.4 FERMACELL dry leveling compound

The grain size of the FERMACELL dry levelling compound is:

0 – 0,25 mm	0 - 5 %
0 – 0,5 mm	0 - 15 %
0 – 1 mm	5 - 35 %
0 – 2 mm	45 - 75 %
0 – 4 mm	85 - 100 %
>8 mm	0 %

#### 2.1.5 FERMACELL dry acoustical compound

The grain size of the FERMACELL dry acoustical compound is:

0 – 0,25 mm	0 - 2 %
0 – 0,5 mm	0 - 5 %
0 – 1 mm	2 - 10 %
0 – 2 mm	40 - 65 %
0 – 4 mm	85 - 100 %
>8 mm	0 %



## 2.2 Density

### 2.2.1 Gypsum fibre boards

The density of the gypsum fibre boards is  $1150 \pm 100 \text{ kg/m}^3$  according annex C.

### 2.2.2 Insulation boards

The density of the insulation board according to EN 1602 are:

EPS DEO 100 kPa hard foam:	$20 \text{ kg/m}^3 + 2,5/-0,5$
mineral wool:	$160 \text{ kg/m}^3 + 35/-15$
wood fibre:	$240 \text{ kg/m}^3 + 25/-10$

### 2.2.3 Dynamic stiffness of the insulation materials

The dynamic stiffness of the insulation materials according to EN 29 052 are:

mineral wool:	90	MN/m <sup>3</sup>
wood fibre:	110	MN/m <sup>3</sup>
EPS DEO 100 kPa hard foam:	20	MN/m <sup>3</sup>

### 2.2.4 FERMACELL flooring elements

The nominal self-weight [kg/m<sup>2</sup>] of the flooring elements are:

type 1:	$22,0 \pm 1,0 \text{ kg/m}^2$
type 2:	$28,7 \pm 1,3 \text{ kg/m}^2$
type 3:	$23,5 \pm 1,1 \text{ kg/m}^2$
type 4:	$23,7 \pm 1,1 \text{ kg/m}^2$
type 5:	$25,5 \pm 1,2 \text{ kg/m}^2$
type 6:	$24,7 \pm 1,3 \text{ kg/m}^2$

### 2.2.5 FERMACELL dry leveling compound

The density dried to constant mass of the FERMACELL dry leveling compound is  $430 \pm 40 \text{ kg/m}^3$  determined according to DIN 4226.

### 2.2.6 FERMACELL dry acoustical compound

The density dried to constant mass of the FERMACELL dry acoustical compound is  $1500 \pm 100 \text{ kg/m}^3$  determined according to DIN 4226.

## 2.3 Moisture content

### 2.3.1 Gypsum fibre boards

The moisture content of the gypsum fibre boards can be between 1,0% and 1,5% according to annex C.

## 2.4 Strength

### 2.4.1 Gypsum fibre boards

The bending strength is  $\geq 5,8 \text{ N/mm}^2$  according to annex C.

### 2.4.2 FERMACELL flooring elements

The bending strength of the FERMACELL flooring elements as a percentage of the bending strength of the gypsum fibre board is (according to annex C) at least 70 %.

### 2.4.3 FERMACELL floor glue

The bonding strength of the FERMACELL floor glue is tested according to the test methods and characteristics that are agreed between Fermacell GmbH and Kiwa.

**2.5 Reaction to fire**

Based on tests carried out according to EN ISO 9239-1, critical flux in combination with EN ISO 11925-2 (Ignitability) and the EN ISO 1716 (Calorific potential).

The FERMACELL flooring meets according to EN 13501 (classes of reaction to fire performance of floorings) the following classes:

- Types 1, 2 and 6 (see Table 1, pg. 5) meets the Class A2fl – s1;
- Types 3 and 5 (see Table 1, pg. 5) meets the Class Bfl – s1.

**2.6 Resistance to fire**

The contribution of the floor finishing systems to the resistance to fire on a floor section is limited because of the fact that the resistance to fire is tested down-top, no performances are determined in this way.

**2.7 Airborne sound insulation**

The laboratory sound insulation value  $R_w$  (C; Ctr; C100-5000; Ctr, 100-5000) (according to EN ISO 140-3) of the following floor sections are given in table 3.

For a detailed cross section of the timber floor built up see Annex D.

**2.8 Impact sound insulation**

The laboratory sound insulation value  $L_{n,w}$  (Cl) (according to EN ISO 140-6) of the following floor sections are given in table 3.

The impact sound improvement index values  $\Delta L_w$  (according to EN ISO 140-8) of the following floor sections are given in table 4.

	FERMACELL Flooring element 2 E 32	FERMACELL Flooring element 2 E 31	FERMACELL Flooring element 2 E 13
IMPACT INSULATION ON CONCRETE FLOORS	20 mm gypsum fibre board 10 mm mineral wool	20 mm gypsum fibre board 10 mm wood fibre	20 mm gypsum fibre board 20 mm EPS hard foam
	$\Delta L_w$	$\Delta L_w$	$\Delta L_w$
	20 dB	21 dB	17 dB

Table 4  
 Impact sound insulation on concrete floors.

**2.9 Thermal conductivity**

For the calculation of the thermal conductivity of the complete floor section the declared thermal conductivity  $\lambda_D$  [W/(m\*K)] of the following materials can be used:

EPS DEO 100 kPa hard foam: 0,040 W/(m\*K)

The contribution of the other materials to the thermal conductivity is limited.

**Table 3: TIMBER FLOORS WITH FERMACELL 2E31 ACCOUSTIC FLOORING**

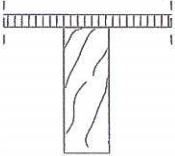
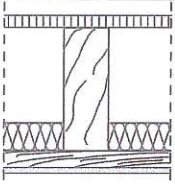
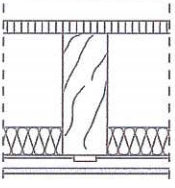
<p><b>ACOUSTIC FLOORING BUILD-UP</b></p> <p><b>Reference construction</b></p>		Reference construction		<i>FERMACELL Flooring Element 2 E 31</i> 20mm gypsum fibre boards 10mm Woodfibre	<i>FERMACELL Flooring Element 2 E 31</i> 20mm gypsum fibre boards 10mm Woodfibre 30 mm FERMACELL accoustical compount 45 kg/m2	<i>FERMACELL Flooring Element 2 E 31</i> 20mm gypsum fibre boards 10mm Woodfibre 60 mm FERMACELL accoustical compount 90 kg/m2
 <p><b>Timber floor with exposed joints</b> 22 mm chip board 200mm joints</p>	Rw (C,Ctr)	28 (0, -1) dB	43 (-2, -6) dB	53 (-2, -8) dB	55 (-2, -9) dB	
	C 100-5000	0 dB	-1 dB	-1 dB	-1 dB	
	Ctr 100-5000	-1 dB	-6 dB	-8 dB	-9 dB	
	Ln,w (Ci)	86 (-3) dB	80 (-3) dB	65 (-1) dB	59 (0) dB	
 <p><b>Timber floor with closed ceiling</b> 22 mm chip board 200mm joints 50 mm mineral wool 30 mm cross-batten 10mm FERMACELL</p>	Rw (C,Ctr)	45 (-3, -8) dB	48 (-2, -8) dB	55 (-4, -11) dB	57 (-5, -12) dB	
	C 100-5000	-2 dB	-1 dB	-3 dB	-4 dB	
	Ctr 100-5000	-8 dB	-8 dB	-11 dB	-12 dB	
	Ln,w (Ci)	77 (0) dB	71 (0) dB	62 (2) dB	59 (1) dB	
 <p><b>Timber floor with closed ceiling</b> 22 mm chip board 200mm joints 50 mm mineral wool 30 mm Acoustic Hangers e.g. TPS System 10mm FERMACELL</p>	Rw (C,Ctr)	56 (-3, -8) dB	59 (-1, -6) dB	62 (-2, -6) dB	62 (-1, -6) dB	
	C 100-5000	-2 dB	0 dB	-1 dB	0 dB	
	Ctr 100-5000	-9 dB	-6 dB	-6 dB	-6 dB	
	Ln,w (Ci)	62 (1) dB	54 (0) dB	45 (0) dB	41 (0) dB	

Note: The achieved improvements are for the specific construction mentioned in table 3.

### 2.10 Thermal inertia

The thermal inertia of the complete floor section can be calculated according to ISO/DIS 13786. For these calculations is required the thermal conductivity [W/(m\*K)], the specific heat capacity [J/(kg\*K)] and density (kg/m<sup>3</sup>) of each material used in the floor section.

For the thermal conductivity the values mentioned in 2.9 and in EN 12524:2000 can be used.

For the specific heat capacity the following materials can be used:

FERMACELL gypsum fibre boards	1,00 kJ/(kg*K)
FERMACELL dry filling slabs	0,95 kJ/(kg*K)
FERMACELL dry acoustical compound	0,80 kJ/(kg*K)

For other materials the specific heat capacity mentioned in EN 12524:2000 can be used.

For the densities the values mentioned in 2.2 can be used.

### 2.11 Water vapour permeability

The water vapour resistance factor  $\mu$  according of the following materials according to EN 12086.

FERMACELL gypsum fibre boards	13	condition 23 – 0/50 (A, dry)
	12	condition 23 – 50/93 (C, wet)

Other water vapour resistance factors can be taken from EN 12524:2000.

### 2.12 Dangerous substances

In addition to the specific clauses relating to dangerous substances contained in this European Technical Approval, there may be other requirements applicable to the products falling within its scope (e.g. transposed European legislation and national laws, regulations and administrative provisions). In order to meet the provisions of the EU Construction Products Directive, these requirements need also to be complied with, when and where they apply.

### 2.13 Resistance to functional failure from hard body impact load

The maximum diameter of the indentations as a result of a hard body impact load is  $\leq 12$  mm for all types of floor finishing systems as meant in annex C.

### 2.14 Recommended areas of application for FERMACELL flooring elements

It is recommendable to use the FERMACELL flooring elements in the following areas:  
(Based on the deformation values under concentrated load given in Table 8, annex C).

Flooring type			with additional third layer (glued 10mm FERMACELL)	
	Area of application	Maximum point load	Area of application	Maximum point load
1 2x10mm FERMACELL gypsum fibre boards	1+2	2,0 kN	1+2+3	3,0 kN
2 2x12,5mm FERMACELL gypsum fibre boards	1+2+3	3,0 kN	1+2+3+4	4,0 kN
3 2x10mm FERMACELL gypsum fibre boards + 20mm PS 20	1+2	2,0 kN	1+2+3	3,0 kN
4 2x10mm FERMACELL gypsum fibre boards + 30mm PS 20	1+2	2,0 kN	1+2+3	3,0 kN
5 2x10mm FERMACELL gypsum fibre boards + 10mm wood fibre	1+2+3	3,0 kN	1+2+3+4	4,0 kN
6 2x10mm FERMACELL gypsum fibre boards + 10mm mineral wool	1	1,0 kN	1	1,5 kN

**Table 5**  
 Recommended areas of application.

Possible additional layers below the FERMACELL flooring elements without changing the allowable point load:

- 10 to 30 mm FERMACELL dry levelling compound;
- 30 or 60 mm FERMACELL acoustical compound.

The allowable point load for other layers below the FERMACELL flooring elements has to be cleared with the manufacturer.

Areas of application based on EN 1991 are:

EN 1991	Areas of application	
A	1	Living rooms, kitchens, corridors and attic conversions in dwellings. Hotel rooms and their baths
B	2	Offices, corridors and attic conversions in office buildings.
C1	3	Corridors in hotels. Surfaces with desks e.g. coffee shops, classrooms, restaurants, reception rooms.
C2, C3 C4, D1, D2	4	Circulation areas in public buildings, churches, theatres and playhouses, exhibition and display areas, shops and warehouses. Treatment rooms and corridors in hospitals. Corridors in schools and colleges.

### 3 EVALUATION OF CONFORMITY AND CE-MARKING

#### 3.1 Attestation of Conformity system

The systems of attestation of conformity specified by the European Commission in mandate 97/808/EC for rigid flooring products are as follows:

**System 3 (See CPD Annex III.2.(ii), second possibility):**

For rigid flooring elements with Euroclasses Afl, Bfl, or Cfl concerning Reaction to fire, and where the reaction to fire performance is not susceptible to change during the production process.

#### 3.2 Responsibilities

##### 3.2.1 Tasks of the manufacturer

**3.2.1.1 Factory production control**

The manufacturer must carry out the inspections, calibrations and tests according to the scheme that is agreed between Fermacell GmbH and Kiwa.

Furthermore the manufacturer must have and work according to the following procedures:

- treatment of products which do not conform;
- recording of verification and tests;
- traceability;
- dealing with complaints in respect of products supplied.

##### 3.2.2 Tasks of approved bodies

Initial type-testing of the product by an approved laboratory.

#### 3.3 CE-marking

The CE marking shall be affixed on the products, the packaging or the attached label.

The symbol "CE" shall be accompanied by the following information:

- name or identifying mark of the producer;
- last two digits of the year in which the marking was affixed;
- number of the EC certificate of conformity (System 3);
- number of the ETA;
- class of reaction to fire.

## 4 ASSUMPTIONS UNDER WHICH THE FITNESS OF THE PRODUCT(S) FOR THE INTENDED USE WAS FAVOURABLY ASSESSED

### 4.1 Manufacturing

The manufacturing process of the products is in accordance with the process that is agreed between Fermacell GmbH and Kiwa.

### 4.2 Installation

- Before installing the FERMACELL flooring elements the house or building must be protected by floors, walls and roofs which prevent infiltration and penetration of rain, snow etc and of groundwater in the work.
- The FERMACELL flooring elements must be installed on structural floors which provide overall support to the flooring elements.
- Unevenness should be leveled:
  - Unevenness up to 10 mm can be leveled with the FERMACELL self leveling compound;
  - Unevenness from 10 mm to 60 mm can be leveled with the FERMACELL dry leveling compound;
  - From 40 mm to 2.000 mm can be leveled with the FERMACELL bonded leveling compound.
- Before installing the FERMACELL flooring elements on a concrete floor that still contains moisture lay a damp proof membrane on the concrete floor in order to avoid water absorption in the flooring elements.
- When dry leveling compound is used, first lay the FERMACELL trickle protection sheet if necessary.
- When the FERMACELL flooring elements are used on a ground floor or a floor where the space below is exposed to the elements the floor section must be designed in a way that interstitial condensation will not occur.
- Lay a strip of FERMACELL perimeter insulation along the outer edges against the walls. When fire protection is a requirement use a strip of mineral wool. See figure 1 (Annex B).
- Lay the FERMACELL flooring elements as shown in figure 2 (Annex B). The overlapping seam is cut from the first elements to make sure they fit closely to the wall. Avoid cross joints.
- The seams are glued and fastened with FERMACELL dry flooring screws to achieve the necessary pressure on the glue in the joints. See figure 6 (Annex B). It is also possible to use recommended expanding staples.
- Lay a third layer FERMACELL on top of the floor built up to increase the concentrated point load. The FERMACELL building boards should be laid at 90° to the axis of the dry flooring elements. See figure 7 (Annex B). This additional layer has to be glued (FERMACELL floor glue in beads spaced at intervals of 100 mm or less) and fixed (with FERMACELL countersunk cross-slot screws or special expanding staples) on the FERMACELL dry flooring elements. The third layer is laid with staggered joints, all the joints have to be offset by a minimum of 200 mm from the nearest parallel joint in the dry flooring elements.
- Once the FERMACELL floor glue has set and any excess material has been chipped off the joints and screws or staples heads can be stopped and smoothed with joint filler. Any perforations in the floor should be designed and installed in conformity with the required resistance to fire, airborne sound insulation and thermal resistance.

For further information: please see the instruction manual of Fermacell GmbH.

## **5 RECOMMENDATIONS FOR THE MANUFACTURER**

### **5.1 Recommendations on packaging, transport and storage**

The FERMACELL flooring elements shall be wrapped so that they are protected from moisture during transport and storage, unless other measures are provided by the manufacturer for this purpose. The FERMACELL flooring elements and other components of the kit shall be handled and stored with care and be protected from accidental damage. The flooring elements must be protected from moisture during transport, storage and installation.

### **5.2 Recommendations on use, maintenance, repair**

The insulating dry floor finishing systems with FERMACELL flooring elements are intended for use in new build and existing (refurbishment) houses and other buildings for raising the height of floors or leveling out uneven floors. They can only be used on structural floors which provide overall support to the flooring elements. The space below the floor on which the floor finishing systems are used can be either an interior environment or exposed to the elements.

The FERMACELL floor finishing systems must not be exposed to higher concentrated loads than mentioned in the ETA.

The dry floor finishing systems are not intended to be used without a floor covering. In wet rooms the floor finishing systems must be lined with a waterproof floor covering. Special attentions must be paid to waterproof detailing of the floor-wall connection and perforations.

The following floor coverings can be used: textile, PVC, Ceramic stoneware tiles, natural tiles, terracotta, marble tiles, cork and parquet. The mentioned floor coverings must be applied according to the recommendation and instructions of the manufacturer of the floor covering.

Other additional layers than the mentioned in table 2 can be used, please contact Fermacell GmbH for further information.



**ANNEX A LIST OF MENTIONED STANDARDS**

DIN 4102-2:1977	Fire Behaviour of Building Materials and Building Components; Building Components; Definitions, Requirements and Tests
DIN 4226-100:2002	Aggregates for mortar and concrete - Part 100: Recycled aggregates
EN ISO 140-3:1995	Acoustics – Measurements of sound insulation in buildings and of building elements-Part 3: Laboratory measurements of airborne sound insulation of building elements.
EN ISO 140-6:1998	Acoustics – Measurements of sound insulation in buildings and of building elements-Part 6: Laboratory measurements of impact sound insulation of floors.
EN-ISO 140-8:1997	Acoustics – Measurements of sound insulation in buildings and of building elements-Part 8: Laboratory measurements of the reduction of transmitted impact noise by floor coverings on a heavyweight standard floor.
EN 822:1994	Thermal insulating products for building applications. Determination of length and width
EN 824:1994	Thermal insulating products for building applications. Determination of squariness
EN-ISO 1716:2002	Reaction to fire tests for building products - Determination of the heat of combustion
EN 1991-1-1:2002	Eurocode 1 – Actions on structures. General actions. Densities, self-weight, imposed loads for buildings
EN 1365-2:1998	Fire resistance tests for load bearing elements - Part 2 Floors and Roofs
EN 1602:1996	Thermal insulating products for building applications. Determination of density
EN-ISO 9239-1:2002	Reaction to fire tests for floorings -- Part 1: Determination of the burning behaviour using a radiant heat source
ISO 11925 -2:2002	Reaction-to-fire tests;Ignitability of building products subjected to direct impingement of flame;Part 2: Single-flame source test
EN 12086:1997	Thermal insulating products for building applications - Determination of water vapour transmission properties
EN ISO 12431:1998	Thermal insulating products for building applications - Determination of thickness for floating floor insulating products and EN 12431:1998/A1:2006
EN 12524:2000	Building materials and products; Hygrothermal properties;Tabulated design values
EN 13162:2001	Thermal insulation products for buildings- Factory made mineral wool products - Specification and EN 13162:2001/AC:2005
EN 13163:2001	Thermal insulation products for buildings- Factory made products of expanded polystyrene – Specification and EN 13163:2001/AC:2005
EN 13171:2001	Thermal insulation products for buildings- Factory made wood fibre products – Specification EN 13171:2001/A1:2004 and EN 13171:2001/AC:2005
EN 13501-1: 2007	Fire classification of construction products and building elements - Part 1: Classification using data from reaction to fire tests
ISO/DIS 13786:2007	Thermal performance of building components -- Dynamic thermal characteristics -- Calculation methods
EN 29052:1992	Acoustics - Determination of dynamic stiffness - Part 1: Materials used under floating floors in dwellings
NEN 1775:1991	Bepaling van de bijdrage tot brandvoortplanting van vloeren

ANNEX B: Drawings

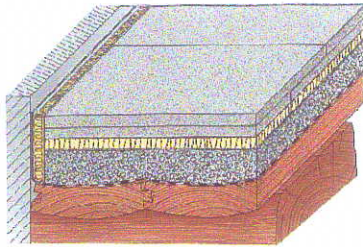

Timber floor

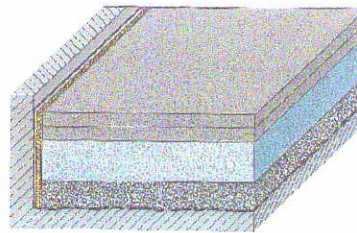

Concrete floor

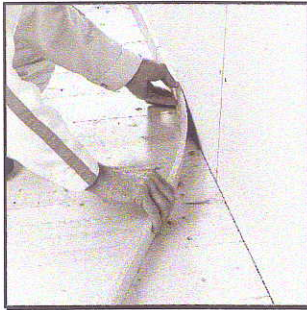

figure 1

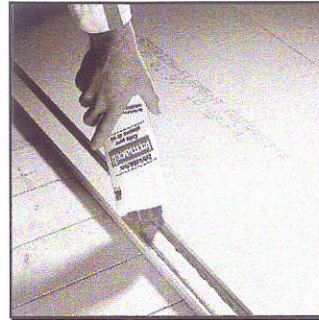

figure 4

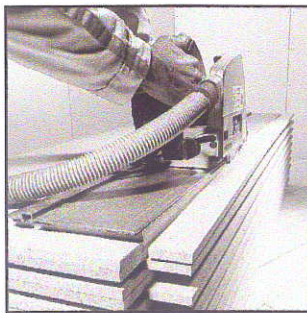

figure 2

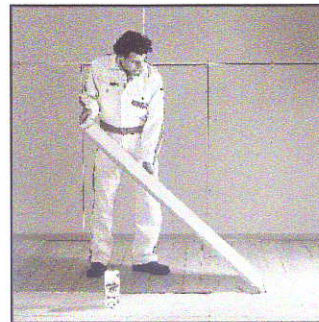

figure 5

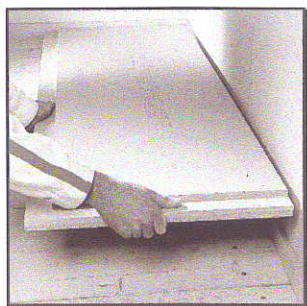

figure 3

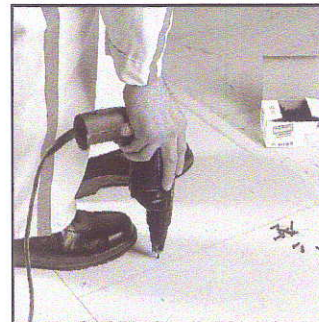

figure 6

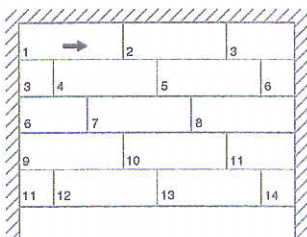
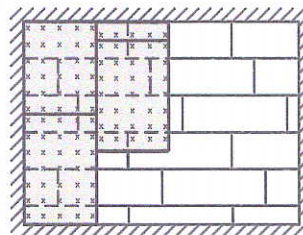

Figure 1



Installing a third layer of FERMACELL

Figure 7 laying the flooring elements

## ANNEX C: METHODS OF VERIFICATION

### 1. Density of gypsum fibreboards (CUAP 4.2.1)

Determination of the density of 6 samples with dimensions of 400 x 400 mm (dried to constant weight). The average of the 6 determined densities must be calculated. The average value must meet the requirement.

### 2. Moisture content of gypsum fibre boards (CUAP 4.3.1)

Cut two samples with dimensions of 400 x 400 mm from one board. Determine the mass of the samples. Dry the samples to constant mass and determine again the mass of the samples. Sampling and drying as described in § 6.4 of EN 520.

The moisture content of the samples is expressed as a percentage of the mass after drying (accuracy 0,1 %).

$$\% \text{ moisture} = \frac{m_{\text{before drying}} - m_{\text{dry}}}{m_{\text{dry}}}$$

The average moisture content of the two samples must meet the requirement.

### 3. Bending Strength (CUAP 4.4.2)

Cut two samples from a flooring element (without an insulation layer) as shown below. In the same way cut also two samples from an gypsum fibre board of the same production. Determine the breaking load (accuracy in 10 N) of the samples. One longitudinal to production direction and one transversal. The testing machine must be in accordance with § 6.4 of EN 520. Calculate the bending strength (accuracy 0,1 N/mm<sup>2</sup>) of each sample. Calculate the bending strength expressed as a percentage of the bending strength of the gypsum fibre board as follows:

$$\% \text{ bending strength flooring element} = 100 \% \times \frac{\text{bending strength flooring element}}{\text{bending strength gypsum fibre boards}}$$

### 4. Resistance to functional failure from hard body impact load (CUAP 4.12)

Let a steel ball with a diameter of 50 mm and a mass of 515 g fall from standstill and a height of 500 mm on the upper side of the flooring elements at three different points, with a distance to the edges of > 100 mm. The flooring elements must lie on a rigid underground (level and completely supported). Determine the diameter of the indentation (accuracy 1 mm).

### 5. Resistance to functional failure from concentrated load (CUAP 4.13)

Lay a test floor area of approximately 9 m<sup>2</sup> (3 m x 3 m) as shown in the figure below of the considered floor finishing system according to the installation guide.

The following five places of the floor area have to be tested:

- 1) the edges of the floor area E1, E2, E3 and E4;
- 2) the border of the floor area R1, R2, R3 and R4;
- 3) the middle of the floor area M1 and M2.

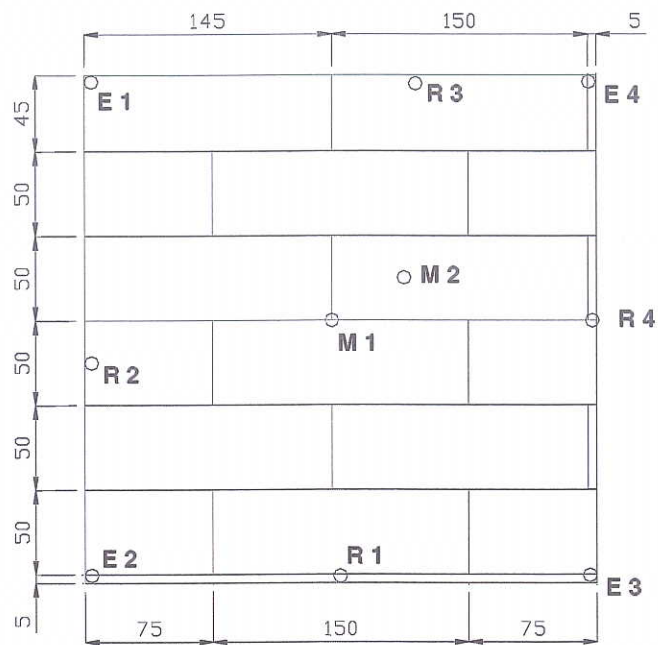

Apply at each point a concentrated load of 0,2 kN at an area of  $\varnothing$  50 mm. Increase this load with steps of 0,2 kN and above a concentrated load of 1,0 kN with steps of 0,5 kN until functional failure. Determine the deformation by every step of 0,2 kN/0,5 kN, 2 minutes after reaching the load. Determine the average deformation by a concentrated load of 0,8 kN, 1,0 kN, 1,5 kN, 2,0 kN, 2,5 kN, 3,0 kN, 3,5 kN and 4,0 kN:

- E1, E2, E3 and E4;
- R1, R2, R3 and R4;
- M1 and M2.

Determine the minimum functional failure loads of:

- E1, E2, E3 and E4;
- R1, R2, R3 and R4;
- M1 and M2.

**European Technical Approval ETA-03/0006**  
**Kiwa – K25203/03**

Resistance to functional failure from concentrated load

The deformation [mm] under concentrated loads for the following floor finishing systems are:

Type		load [kN]								Failure load [kN]
		0,8	1,0	1,5	2,0	2,5	3,0	3,5	4,0	
1	M	0,7	0,9	1,3	1,7	2,0	2,3	2,5	2,8	6,8
	R	1,1	1,2	1,5	2,0	2,4	3,0	3,8	4,7	4,4
	E	1,0	1,2	1,9	3,1	-	-	-	-	2,4
2	M	0,4	0,5	0,6	0,8	0,9	1,0	1,2	1,3	9,2
	R	0,9	1,1	1,5	1,7	2,0	2,3	2,6	3,1	5,0
	E	1,0	1,2	1,6	2,3	3,1	-	-	-	2,6
3,4	M	0,7	0,9	1,3	1,7	2,0	2,3	2,5	2,8	6,8
	R	1,1	1,2	1,5	2,0	2,4	3,0	3,8	4,7	4,4
	E	1,0	1,2	1,9	3,1	-	-	-	-	2,4
5	M	0,4	0,5	0,7	0,9	1,0	1,2	1,4	1,8	8,0
	R	1,1	1,3	1,6	1,9	2,2	2,5	2,9	3,3	6,8
	E	1,2	1,4	2,0	2,5	3,1	-	-	-	3,0
6	M	0,7	0,8	1,1	1,4	1,7	2,0	2,4	2,8	5,8
	R	1,6	1,9	2,5	3,1	3,8	4,6	5,4	6,5	4,2
	E	2,5	3,1	4,4	5,8	-	-	-	-	2,2
7	M	see the values for the relevant type 1 to 6								
	R									
	E									
8	M	0,3	0,4	0,5	0,7	0,9	1,0	1,2	1,4	9,4
	R	0,7	0,8	1,1	1,4	1,7	2,0	2,4	2,9	5,6
	E	1,2	1,4	1,9	2,5	3,3	-	-	-	3,0
9	M	0,3	0,4	0,5	0,7	0,8	1,0	1,1	1,3	12,0
	R	0,8	1,0	1,3	1,6	1,9	2,2	2,5	2,7	7,2
	E	0,6	0,7	1,2	1,8	2,4	3,0	3,7	-	3,8
10	M	0,3	0,4	0,6	0,8	0,9	1,2	1,3	1,8	10,8
	R	1,0	1,2	1,4	1,8	2,1	2,4	2,8	2,9	9,0
	E	0,8	0,9	1,6	2,0	2,4	3,0	3,7	-	4,2
11	M	0,7	0,8	1,1	1,4	1,7	2,0	2,4	2,8	9,4
	R	1,6	1,9	2,5	3,1	3,8	4,6	5,4	6,5	5,4
	E	2,5	3,1	4,4	5,8	-	-	-	-	2,8
12,13	M	see the values for the relevant type 6 or 7								
	R									
	E									

**Table 8**

Deformation [mm] under concentrated loads.

Notes table 8

- E = edge, R = border and M = middle.
- The deformation and the failure load are determined according to annex C-5.
- These values must be divided by the safety factor which is in force at the place where the product is used.
- For other floor build ups not included in this table, take contact to with the manufacturer.
- Recommended areas of application for the tested flooring systems are given in table 6 (areas of application according to EN1991).

ANNEX D: Detailed cross section of the timber floors (Table 3 page 10)

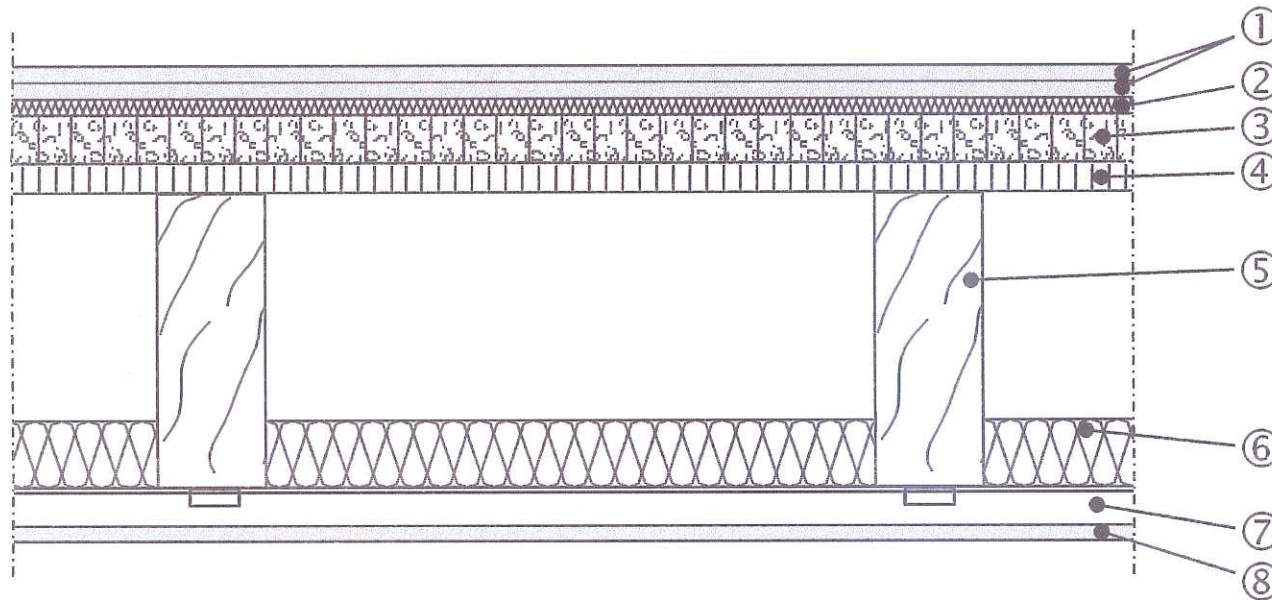

System 14 (Page 5):

- ① 2x10mm FERMACELL Gypsum fibre boards
- ② 10mm wood fibre
- ③ 30mm acoustical compound (45g/m<sup>2</sup>)
- ④ 22mm chip board (13,9 kg/m<sup>2</sup>)
- ⑤ 200/80 joints (e = 625mm)
- ⑥ 50mm mineral wool (airflow resistance = 5kPa s/m<sup>2</sup>)
- ⑦ 30mm acoustic hangars (e.g. TPS System)
- ⑧ 10mm FERMACELL gypsum fibre boards

Fermacell GmbH  
Düsseldorfer Landstraße 395  
D-47259 Duisburg  
Germany

[www.fermacell.de](http://www.fermacell.de)

The logo for fermacell, featuring the word "fermacell" in a lowercase, sans-serif font with a registered trademark symbol (®) to the upper right. The text is white and is set against a dark orange background.

**For the latest version of this  
brochure please visit our website  
[www.fermacell.de](http://www.fermacell.de)  
[www.fermacell.com](http://www.fermacell.com)**

Technical modifications subject to changes.  
Last updated: 04/2014

The most recent edition applies.  
Should you require additional information,  
please contact our fermacell customer  
service.

fermacell customer service:  
phone +49 (0) 203 60 880-3  
fax +49 (0) 203 60 880-8399  
e-mail [info@xella.com](mailto:info@xella.com)

fermacell® is a registered trademark  
and a company of the XELLA group.